

REV.	ECN.NO.	NAME	DATA
A0	N/A	Peter	2013-10-10

NOTES

1. Housing Polycarbonate(PC), UL 94V-0 or UL94V-2.
2. Terminal Brass, selective gold plating over nickelGold plating: G/F inch, 3u inch, 6u inch, 15u,inch, 30u inch, 50u inch.
3. Insulation Resistance: 1000 Megohms min.
4. Withstand Voltage: 1000V, AC/minute.
5. Durability: 1000mating circles min.

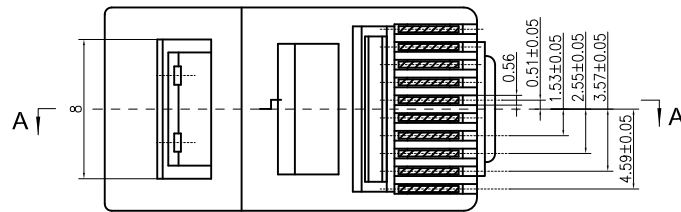

SECTION A-A

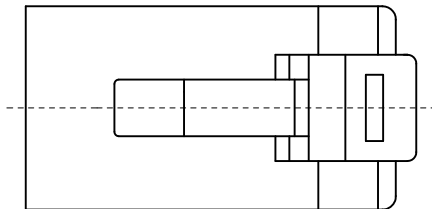
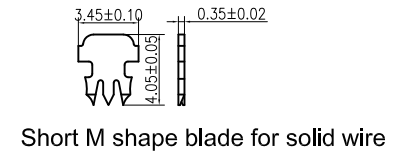
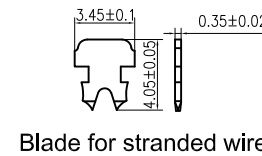
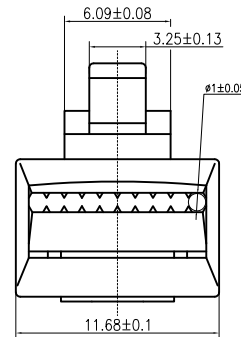
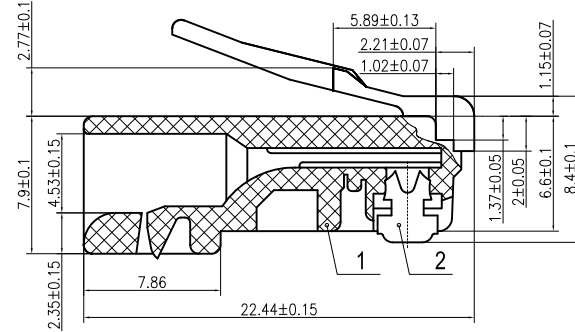
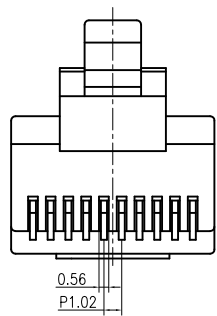

DETACHED LISTS	MM ← INCH →	绘图: (Designed)	库乐科技									
	公差: TOLERANCES	审核: (Checked)			名称(NAME)							
	<table border="1" style="font-size: small;"> <tr> <td>MM</td> <td>MM</td> </tr> <tr> <td>.0 ± .020</td> <td>.0 ± 0.38</td> </tr> <tr> <td>.00 ± .015</td> <td>.00 ± 0.25</td> </tr> <tr> <td>.000 ± 0.075</td> <td>.000 ± 0.15</td> </tr> </table>	MM	MM	.0 ± .020	.0 ± 0.38	.00 ± .015	.00 ± 0.25	.000 ± 0.075	.000 ± 0.15	批准: (Approved)	Modular Plug 10P10C	
	MM	MM										
.0 ± .020	.0 ± 0.38											
.00 ± .015	.00 ± 0.25											
.000 ± 0.075	.000 ± 0.15											
角度(ANGLES) ± 1.5°	材料: (Material)	图号(DWG NO.):	版本 REV.	A0								
 第三角视图	比例: (SCALE)	料号(PART NO.):	第(OF)1页									
	1:1	单位(UNIT): MM			共(SHEET)1页							